



ALL-WEATHER SPEAKER SYSTEM



全天候扬声器系统

引领者

2023

www.fdbaudio.com



FDB AUDIO MANUFACTURE CO.,LTD.

我们的企业

ABOUT US

FDB Audio Manufacture Co., Ltd. is a professional audio company integrating R&D, production, sales and engineering services. FDB Audio builds a high-quality and stable professional team with advanced R&D, production and testing equipments and instruments, and establishes cooperative development mechanism with a number of world-class professional materials, accessories manufacturers and testing institutions.

The main products are professional speaker units, professional speaker systems and matching electronic products.

“Let the voice of harmony resound through the world” is our corporate vision, let the voice of peace and harmony resound around the world through our products and services.

“Achieve partners ,serve the society” is our corporate mission. We believe that the achievement of customers, suppliers and employees is to achieve ourselves, to make the greatest contribution to social progress.

“Pursue better, share together” is our value, which aims to research and develop, manufacture better products, provide better services, obtain reasonable profits, share with customers, staffs and suppliers.

FDB Audio has established and strictly implemented the quality management system of ISO9001-2015 standard. **“Clear basis, perfect procedure, strict implementation, cherish environment, care for health, customer satisfaction.”** is our policy.

On the basis of strong electroacoustic research technology and more than 30 years of industry practice, and with the business philosophy of **“Ambitiously conceive, pragmatically do”**, we provide customers with stable and reliable quality, leading technology and continuous improvement of professional audio products and services.

爱高音响有限公司是集研发、生产、销售及工程服务为一体的专业音响公司。建设有一只高素质、稳定的专业团队，拥有先进的研发设计、生产检测设备及仪器，与多家世界级专业材料、配件厂商、测试机构建立合作开发机制。

主要产品有专业扬声器单元，专业扬声器系统及配套的电子产品，是全天候专业扬声器系统的引领者。

“让和谐之声响彻天下”，是我们的企业愿景，旨在通过我们的产品及服务让和平、和谐的声音在世界各地响起。

“成就伙伴、服务社会”，是我们的企业使命，我们认为：成就客户、供应商、员工就是成就我们自己，为社会进步做出最大贡献。

“追求更好，共同分享”，是我们的价值观，意在研发，制造更好的产品，提供更优质的服务，获得合理的利润，与顾客、员工、供应商共同分享。

公司建立并严格执行ISO9001-2015标准的质量管理体系，**“依据明确，流程健全，严格执行，呵护环境，注重健康，顾客满意”**是我们的方针。

我们凭借着雄厚的电声学研究技术和三十多年的行业实践为基础，以**“壮志凌云地想，脚踏实地地干”**为经营理念，向顾客提供质量稳定可靠、技术含量领先、并持续提高的专业音响产品与服务。

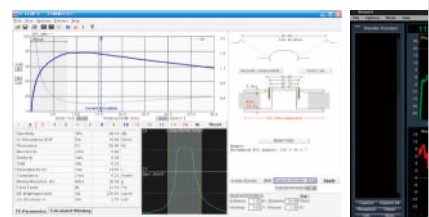



ALL-WEATHER SPEAKER SYSTEM

COMPANY VALUES

Vision: Let the voice of harmony resound through the world.
Mission: Achieve partners ,serve the society.
Value: Pursue better, share together.
Spirit: Unity, diligence, pragmatism, innovation.
Policy: Clear basis, perfect procedure, strict implementation,
cherish environment, care for health, customer satisfaction.
Business Philosophy: Ambitiously conceive, pragmatically do.

公司价值准则

企业愿景: 让和谐之声响彻天下。
企业使命: 成就伙伴，服务社会。
价值观: 追求更好，共同分享。
企业精神: 团结勤奋，务实创新。
企业方针: 依据明确，流程健全，严格执行，
呵护环境，注重健康，顾客满意。
经营理念: 壮志凌云地想，脚踏实地地干。

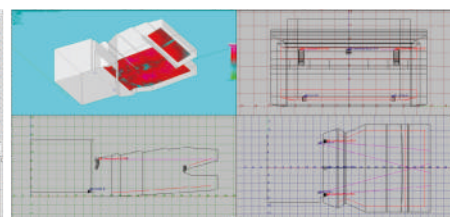
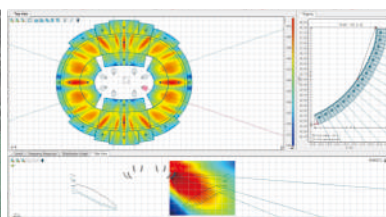
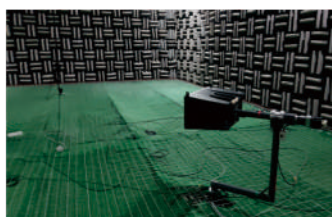



我们的荣誉及专利

OUR HONOR AND PATENTS

高新技术产品认证

HIGH-TECH PRODUCT CERTIFICATION

全天候音箱/中远程全天候产品 被认定为广东省高新技术产品。
All-weather speaker, mid-long throw all weather product have been identified as high-tech products in Guangdong Province.



专利证书

PATENT CERTIFICATE

全天候音箱实用新型专利/全天候音箱外观专利
All-weather Speaker Utility Model Patent, All-weather Speaker Design Patent



我们的资质及认证

OUR QUALIFICATIONS AND CERTIFICATION



EASE

全天候音箱产品已经录入EASE 声学软件库
All-weather speaker parameters have been entered into EASE loudspeaker database



CE&RoHS 认证

CE&RoHS CERTIFICATION



防水认证

WATERPROOF CERTIFICATION





我们的环境试验

OUR ENVIRONMENTAL TESTING

全天候音响可靠性 环境试验
All-weather Speaker Reliability, Environmental Testing



防尘测试
Dustproof Test

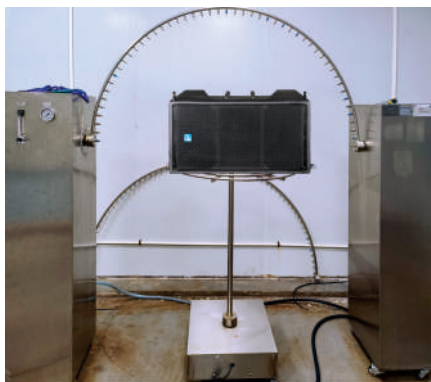

防水测试
Waterproof Test

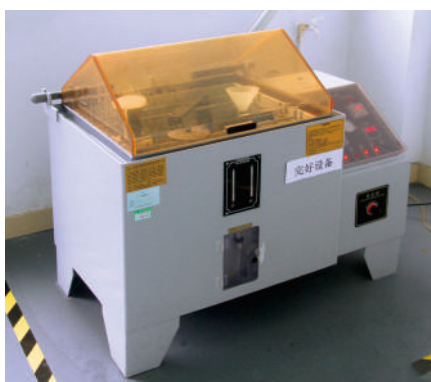

盐雾测试
Salt Spray Test



高低温湿热测试
High-low Temperature Damp Heat Test



寿命测试
Aging Test

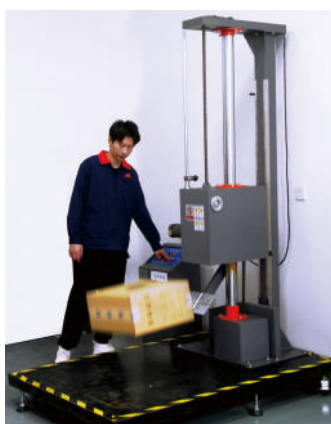

跌落测试
Drop Test



拉力测试
Tensile Test

我们的企业标准

OUR CORPORATE STANDARDS Q/AG ii f01004-2022



全天候音箱可靠性 环境试验 执行标准

All-weather Speaker Reliability, Environmental Testing , Implementation Standard

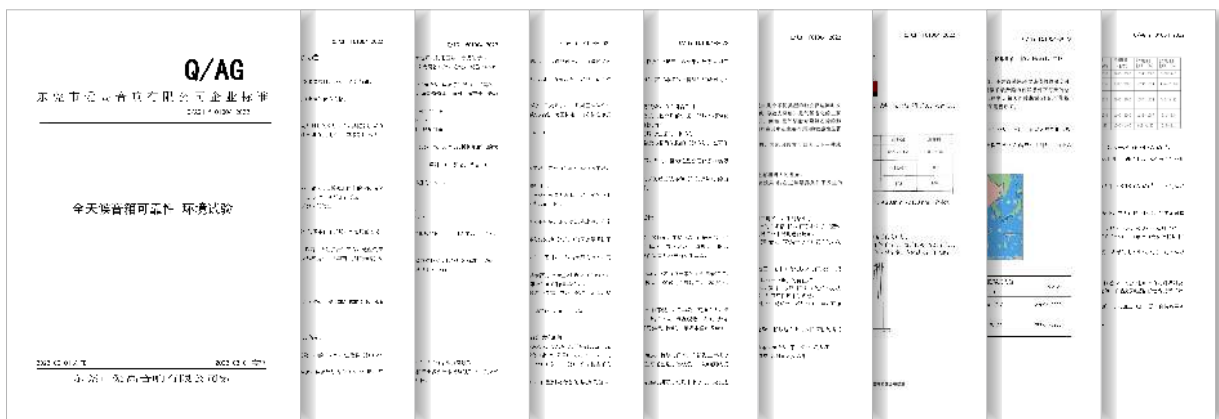

全天候音箱 All-weather Speaker

对运输、贮存、使用环境有广泛适应性，可在极端气候条件下长期户外使用的音箱。

全天候的环境适应力,除符合GB/T 9397耐受振动、滑落冲击、跌落、高温负荷和贮存、低温负荷和贮存、稳态湿热的要求外，还应额外具备防止雨水灰尘侵入、耐受盐雾腐蚀、抗霉菌、抗阳光辐射及低气压适应性。

It has a wide range of adaptability to transportation, storage and use environment, and can be used outdoors for a long time under extreme weather conditions. All-weather environmental adaptability, in addition to the requirements of GB/T9397 tolerance to vibration, slide impact, drop, high temperature load and storage, low temperature load and storage, steady heat bleaching, it should also be additional to prevent the intrusion of rain and dust, withstand salt spray corrosion resistance, mold resistance, solar radiation resistance and low air pressure adaptability.

引用标准 Reference Standard

下列文件中的条款通过本标准的引用而成为本标准的条款。凡是注日期的引用文件，其随后所有的修改单(不包括勘误的内容)或修订版均不适用于本标准。凡是不注日期的引用文件，其最新版本适用于本标准。

The terms in the following documents become terms of this Standard by reference to this Standard. For dated references, all subsequent amendments (excluding erratum) or revisions shall not apply to this Standard. For undated references, the latest version of the document applies to this standard.

GB/T 9397-2013 直接辐射式电动扬声器通用规范

GB 2421-1999 电工电子产品环境试验规程 总则

GB/T 10125-2012/ISO9227:2006 人造气氛腐蚀试验 盐雾试验

GB/T 4208-2017 外壳防护等级 (IP代码)

GB/T 2423.24-2013 电工电子产品环境试验 第2部分：试验方法 试验Sa：模拟地面上的太阳辐射

GB/T 2423.16-2008 电工电子产品环境试验 第2部分：试验方法 试验J和导则：长霉

GB/T 2423.21-2008 电工电子产品环境试验 第2部分：试验方法 试验M：低气压

GB/T9397-2013 General Specification for Direct Radiant Electric Loudspeaker

GB 2421-1999 General Rules for Environmental Testing of Electrical and Electronic Products

GB/T 10125-2012 / ISO9227:2006 Corrosion Test in Artificial Atmosphere, Salt Spray Test

GB/T 4208-2017 Enclosure Protection Class (IP Code)

GB/T2423.24-2013 Environmental Testing of Electrical and Electronic Products, Part two: Test Meathod, Test Sa: Simulates Solar Radiation on The Ground

GB/T2423.16-2008 Environmental Testing of Electrical and Electronic Products, Part two: Test Meathod, Test J and Guide Rule: Mould Growth

GB/2423.21-2008 Environmental Testing of Electrical and Electronic Products, Part two: Test Meathod, Test M: Low Air Pressure Test



我们的工程案例

OUR PROJECT CASE

All-weather Speaker Applications: indoor and outdoor fixed installations, theme parks, ski resorts, camping sites, transportation hubs, municipal squares, stadiums, playgrounds, classrooms, churches, background music for big screens, outdoor restaurants, bars, houseboats, seaside sound reinforcement(to be customized) projects.

全天候扬声器系统适用于：户内外固定安装、主题公园、滑雪场、露营地、交通枢纽、市政广场、体育场、操场，教室，教堂、大屏背景音乐，户外餐厅、酒吧，游艇、海边扩声（需定制）等扩声工程项目。



甘孜藏族自治州职业技术学校
Garz Tibetan Autonomous Prefecture
Vocational and technical school



河源客天下主题乐园
Heyuan's guest world theme park



东莞市第五高级中学
The Fifth High School in Dongguan



温州市文成县百丈漈景区
Wenzhou City Wencheng County Baizhangji
scenic area



牡丹江市田家炳实验中学
Mudanjiang Tian Jia Bing Experimental School



常熟尚湖风景区
Shanghu scenic spot, Changshu



菏泽陈集中学操场
Chan Chi College Playground, Heze



青岛世原会水上乐园
World water park in Qingdao



重庆大渡口翠湖音乐喷泉
Chongqing Dadukou Green Lake Music Fountain



康定市甲根坝学校
Kangding Jiagenba School outdoor
venue audio



泸定一中
Luding School



深圳大浪商业中心
Shenzhen Dalang commercial center



塞浦路斯圣玛曼托斯大教堂
Cyprus - Saint Mamantos Cathedral



塞浦路斯圣乔治教堂
Cyprus - Agios Georgios Church



巴基斯坦贾米亚-穆罕默迪·萨关瓦拉清真寺
Pakistan - Jamia Masjid Muhammadi Sahianwala



以色列佩塔·提克瓦学校
Israel - The Peta Tikwa School



阿曼清真寺
Oman - Mosque



迪拜清真寺
Dubai - Mosque



韩国某体育馆
South Kroea - Sports Hall

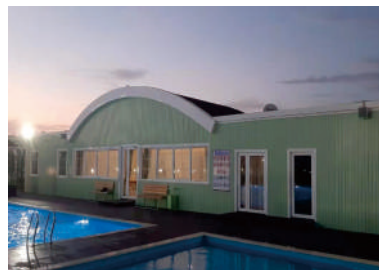

哈萨克斯坦 康福特游泳池
Kazakhstan-Comfort Swimming Pool



塞浦路斯海岩洞清吧
Sea Caves Lounge Bar-Cafe & Restaurant



韩国济州岛咖啡厅
South Korea - The Jeju Island Café



马来西亚鲁姆精品酒店
Malaysia - Rume Boutique Hotel



柬埔寨KAPAL 餐吧
Cambodia - KAPAL Restaurant



塞浦路斯科斯塔斯轮胎服务中心
Cyprus - Costas Tyre



塞浦路斯 默默亚洲鸡肉餐厅
Cyprus - momo Asia kitchen Bar



柬埔寨西哈努克市酒吧
Cambodia-Sihanouk Vile-Pub



FDB AUDIO MANUFACTURE CO.,LTD.

我们的产品

OUR PRODUCTS

- PLA SERIES ALL-WEATHER LINE ARRAY SYSTEM
- LT SERIES ALL-WEATHER MID-LONG THROW SPEAKER
- ES SERIES ALL-WEATHER MULTI-PURPOSE ENGINEERING SPEAKER
- CL SERIES ALL-WEATHER MULTI-FUNCTION COLUMN SPEAKER
- LS SERIES ALL-WEATHER LANDSCAPE SPEAKER

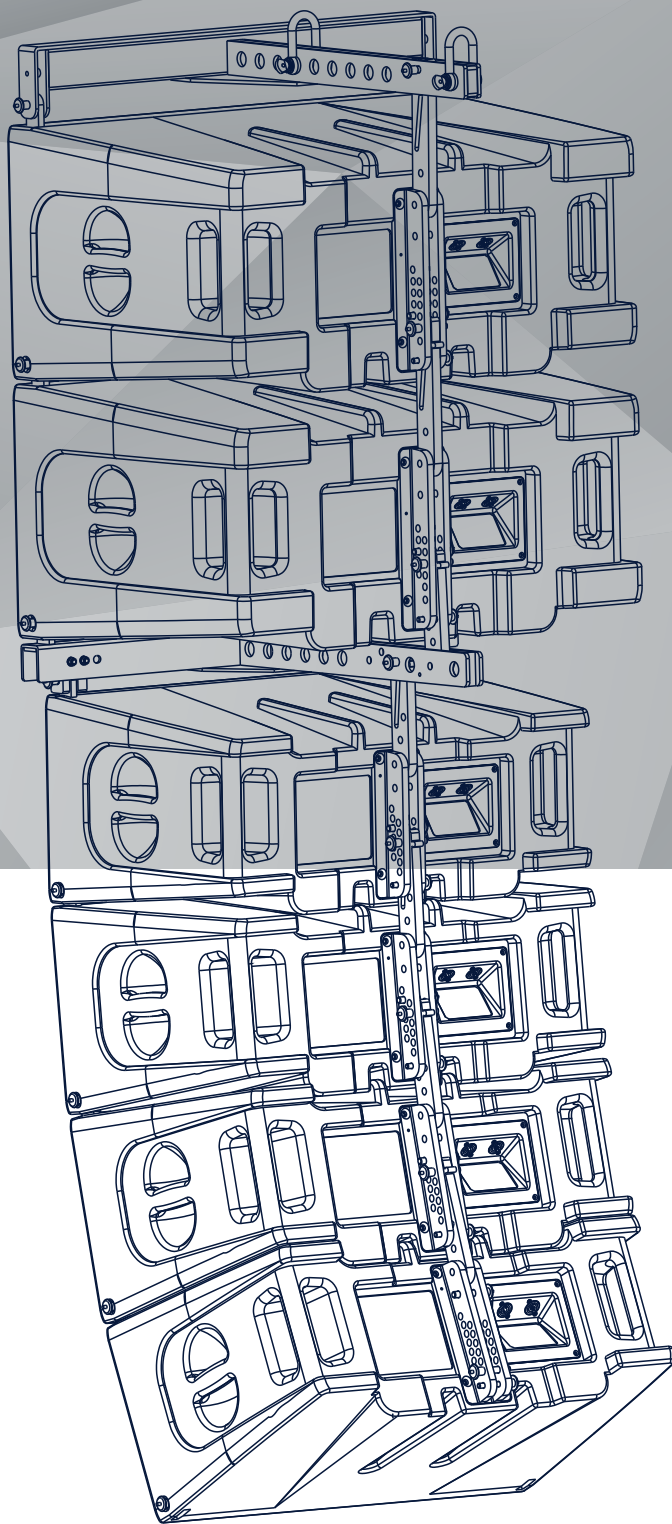

ALL-WEATHER SPEAKER SYSTEM



COMMENTS



PLA SERIES All-weather Line Array System

PAGE 11-16



LT SERIES All-weather Mid-long Throw Speaker

PAGE 17-22



ES SERIES All-weather Multi-purpose Engineering Speaker

PAGE 23-28



CL SERIES All-weather Multi-function Column Speaker

PAGE 29-34



LS SERIES All-weather Landscape Speaker

PAGE 35-36



PLA SERIES

ALL-WEATHER LINE ARRAY SYSTEM

PLA series are all-weather line array speakers, designed with priority given to waterproof, dustproof, windproof, anti-uv aging, and five-layer grille design of different materials. The product meets the IP66 standard, all hanging parts and connecting parts are made of stainless steel or aluminum, features low-distortion mid-bass unit, PLA410 and PLA612 feature mid-high coaxial driver with special waveguide and horn, accurate coverage, three-point hanging system, ensure safety. The cabinet is made of polymer composite material through a special process.

PLA系列是全天候线性阵列音箱，产品设计优先考虑防水、防尘、防风、抗紫外线老化、五层不同材质面网设计。产品满足IP66标准，所有吊挂件、连接件采用不锈钢或铝质喷涂，应用低失真中低音单元，PLA410、PLA612中高音同轴驱动器配上专用波导管及号角，覆盖精确、变化均匀，三点吊挂系统，保证安全。箱体采用高分子复合材料经过特殊工艺成型。

PLA312x4 PCS



PLA410x4 PCS



PLA612x4 PCS



PLA212Bx2PCS+PLA312x4PCS



PLA212Bx2PCS+PLA410x4PCS



PLA212Bx2PCS+PLA612x4PCS





PLA SERIES ALL-WEATHER LINE ARRAY SYSTEM



FEATURES

- Product parameters have been entered into EASE loudspeaker database
- Pass IP66 testing
- Polymer composite material mold forming box, five layers of waterproof, dustproof composite grille, strong weather resistance
- Bi-amp, two-way speaker
- Applications: outdoor fixed installation

产品特点

- 产品参数已录入EASE扬声器数据库
- 通过IP66测试
- 高分子复合材料模具成型箱体，五层防水、防尘复合面网、耐候性极强
- 适用范围：户外固定安装

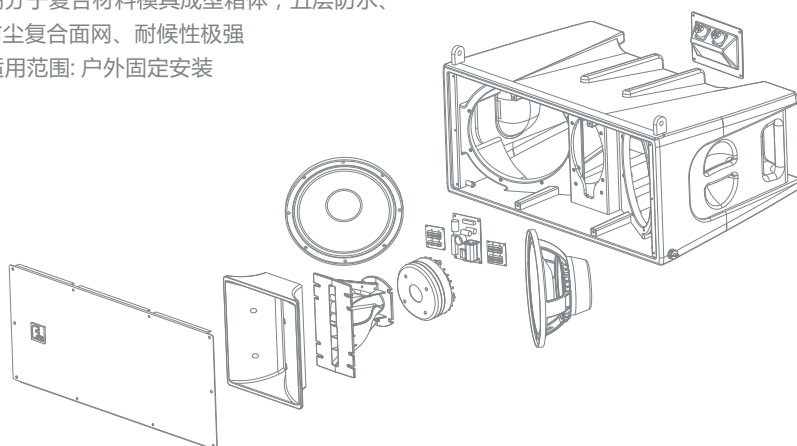



FDB AUDIO MANUFACTURE CO.,LTD.

PLA312

1x12" 2-way All-weather Line Array Speaker

DRIVERS	LF: 1×12"(300mm)/3"voice coil
	HF: 2×1"(25mm)/1.7"voice coil
RATED POWER	400W RMS,1600W peak

PLA410

2x10" 3-way All-weather Line Array Speaker

DRIVERS	LF: 2×10"(250mm)/3"voice coil
	MF: 1×1.4"(36mm)/3.5"voice coil
	HF: 1×1.4"(36mm)/1.7"voice coil
RATED POWER	500W RMS,2000W peak

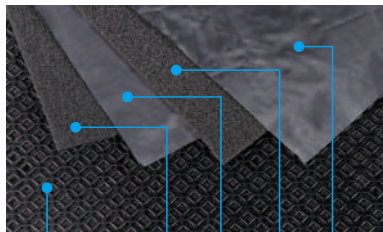
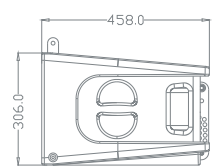
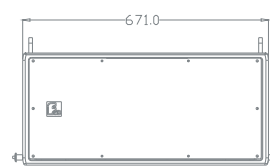
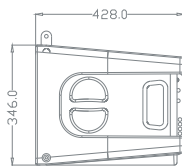

铝质喷涂面网+滤棉+网布+滤棉+网布
 五层保护、防尘、防水面网
 Aluminum grille with powder spray+foam+mesh cloth+foam+mesh cloth, five-layer protection, dustproof, waterproof grille

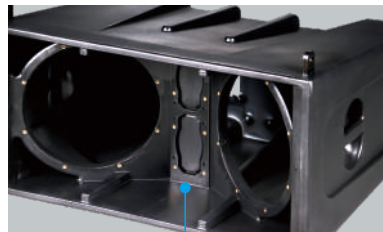

抗紫外线箱体材料
 UV resistant housing material

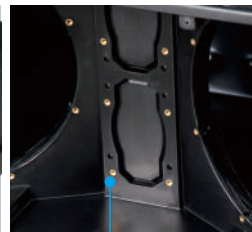

黄铜预埋螺母
 Brass embedded nut

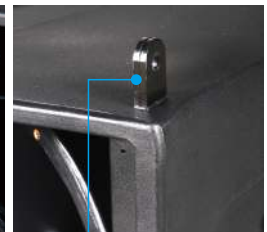

铝合金喷涂嵌入吊挂件
 Embedded aluminum alloy rigging parts with powder spray



PLA SERIES ALL-WEATHER LINE ARRAY SYSTEM

PLA612

2x12" 3-way Bi-amp All-weather Line Array Speaker

DRIVERS	LF: 2×12"(300mm)/3"voice coil
	MF: 2×1.4"(36mm)/3.5"voice coil
	HF: 2×1.4"(36mm)/1.7"voice coil
RATED POWER	LF: 800W RMS, 3200W peak
	MF + HF: 300W RMS, 1200W peak

PLA212B

2x12" All-weather Subwoofer

DRIVERS	LF: 2×12"(300mm)/3"voice coil
RATED POWER	600W RMS, 200W peak

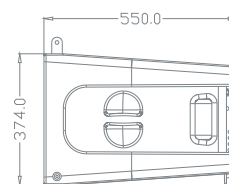
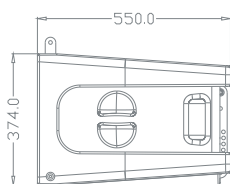

铝合金喷涂吊挂件
Aluminum alloy rigging parts with powder spray

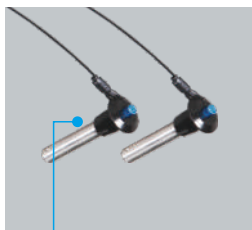

不锈钢插销
Stainless steel pin



铝质喷涂端子板
Aluminum back panel with powder spray



满足IP66标准的插座/插头
Meet the IP66 standard socket and plug



碳钢喷涂处理吊架
Carbon steel rigging frame with powder spray



FDB AUDIO MANUFACTURE CO.,LTD.

ACCESSORIES 附件

RIGGING FRAME



PLA410/PLA312

RIGGING FRAME



PLA212B/PLA612

CONNECT FRAME



PLA212B+PLA410/PLA312

PIN



RIGGING PART



FLIGHT CASE



CONNECTION CABLE



WATERPROOF SOCKET, PLUG



U TYPE LOCK



SPEAKER CABLE





PLA SERIES ALL-WEATHER LINE ARRAY SYSTEM

TECHNICAL SPECIFICATIONS

技术参数

SPECIFICATIONS

MODEL	PLA312	PLA410
FREQUENCY RESPONSE(-3dB)	60Hz-18KHz	70Hz-18KHz
FREQUENCY RESPONSE(-10dB)	55KHz-20KHz	65Hz-20KHz
DRIVERS	1 × 12"(300mm)/3"voice coil LF 2 × 1"(25mm)/1.7"voice coil HF	2 × 10"(250mm)/3"voice coil LF 1 × 1.4"(36mm)/3.5"voice coil MF 1 × 1.4"(36mm)/1.7"voice coil HF
RATED POWER	400W RMS,1600W peak	500W RMS,2000W peak
SENSITIVITY	98dB 1watt/1 metre	101dB 1watt/1meter
MAXIMUM SPL	124dB continuous,130 dB peak	128dB continuous,134dB peak
IMPEDANCE	8 ohms nominal	8 ohms nominal
DISPERSION(-6dB)	Horizontal coverage: 100° Vertical coverage: Varies, depending on array length and configuration	Horizontal coverage: 90° Vertical coverage: Varies, depending on array length and configuration
CROSSOVER FREQUENCIES	1.8kHz passive	700Hz, 6KHz passive
INPUT CONNECTORS	2 × Speakon NL4	2 × Speakon NL4
PACKAGE SIZE	518mm × 436mm × 720mm	550mm × 396mm × 770mm
NET WEIGHT	21 kg/pc	23 kg/pc
GROSS WEIGHT	25 kg/pc	27 kg/pc

MODEL	PLA612	PLA212B
FREQUENCY RESPONSE(-10dB)	LF: 60Hz-1KHz MF + HF: 500Hz-18KHz	50Hz-300Hz
DRIVERS	2 × 12"(300mm)/3"voice coil LF 2 × 1.4"(36mm)/3.5"voice coil MF 2 × 1.4"(36mm)/1.7"voice coil HF	2 × 12"(300mm)/3"voice coil LF
RATED POWER	LF: 800W RMS,3200W peak MF + HF: 300W RMS,1200W peak	600W RMS, 2400W peak
SENSITIVITY	LF: 101dB 1watt/1meter MF + HF: 110dB 1watt/1meter	98dB 1watt/1meter
MAXIMUM SPL	LF: 130dB continuous,136dB peak MF + HF: 134dB continuous,140dB peak	126dB continuous,132dB peak
IMPEDANCE	LF: 8 ohms nominal MF + HF: 16 ohms nominal	8 ohms nominal
DISPERSION(-6dB)	Horizontal coverage: 90° Vertical coverage: Varies, depending on array length and configuration	--
CROSSOVER FREQUENCIES	600Hz passive	--
INPUT CONNECTORS	2 × Speakon NL4	2 × Speakon NL4
PACKAGE SIZE	700mm × 524mm × 931mm	700mm × 524mm × 931mm
NET WEIGHT	39 kg/pc	33 kg/pc
GROSS WEIGHT	46 kg/pc	40 kg/pc



LT SERIES

ALL-WEATHER MID-LONG THROW SPEAKER

LT series are all-weather mid-long throw speakers, with waterproof, dustproof, windproof, anti-uv aging, specially designed dustproof and waterproof cover for input and output, has a pressing device, five-layer different functional grille. The cabinet meets the IP56 standard. The exposed metal parts are made of stainless steel or aluminum, and the mounting bracket is sprayed with low-carbon steel, which can meet all-weather use (the version suitable for the marine environment can be customized, and the mounting bracket is upgraded to 316 stainless steel). The cabinet is made of polymer compound injection molding. Equipped with or without multi-tap transformers.

LT 系列是全天候中远程音箱，具有防水、防尘、防风、抗紫外线老化、输入输出用专门设计的防尘防水盖板，并有迫紧装置，五层不同功能面网设计。产品满足IP56标准，外露金属件采用不锈钢或铝质喷涂，安装支架为低碳钢喷涂满足全天候使用（可以定制适应海洋环境的版本，安装支架升级为316不锈钢）。箱体采用高分子化合物射出成型，配置音频变压器及波段开关，实现多种不同输出功率包括定阻。

LT206/LT206T



LT208/LT208T



LT212/LT212T



LT215/LT215T



LT215L/LT215LT



LT215B/LT215BT





LT SERIES ALL-WEATHER MID-LONG THROW SPEAKER



FEATURES

- Product parameters have been entered into EASE loudspeaker database
- Pass IP56 testing, meet all-weather use
- The cabinet is made of polymer compound injection molding
- Coaxial point sound source
- Horn-loaded design
- Applications: parks, plazas, stadiums, sound reinforcement of scenic area, transportation hubs, houseboats and seaside(customized)

产品特征

- 产品参数已录入EASE扬声器数据库
- 产品通过IP56测试，满足全天候使用
- 箱体采用高分子化合物射出成型
- 同轴点声源
- 号角负载设计
- 适用范围: 主题公园、广场、体育场、景区扩声、交通枢纽海边、游艇、海边户外扩声（需定制）

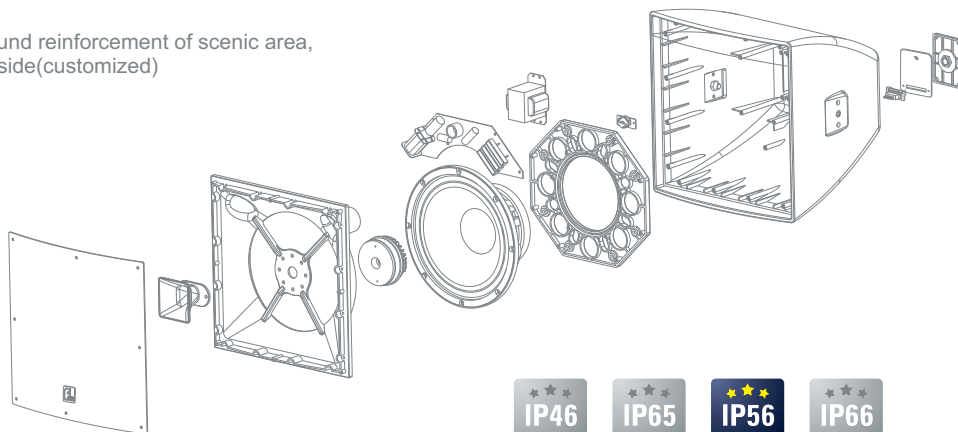



FDB AUDIO MANUFACTURE CO.,LTD.

LT206/LT206T

1x6.5" 2-way Coaxial
All-weather Speaker

DRIVERS	1 × 6.5" (165mm)/1.4" voice coil LF 1 × 1" (25mm)/1" voice coil HF
POWER	100W RMS, 400W peak 25W/50W/100W/OFF/8Ω

LT208/LT208T

1x8" 2-way Coaxial
All-weather Speaker

DRIVERS	1 × 8" (200mm)/2" voice coil LF 1 × 1" (25mm)/1.4" voice coil HF
POWER	150W RMS, 600W peak 37.5W/75W/150W/OFF/8Ω

LT212/LT212T

1x12" 2-way Coaxial
All-weather Speaker

DRIVERS	1 × 12" (300mm)/3" voice coil LF 1 × 1" (25mm)/1.7" voice coil HF
POWER	300W RMS, 1200W peak 50W/100W/200W/OFF/8Ω 300W

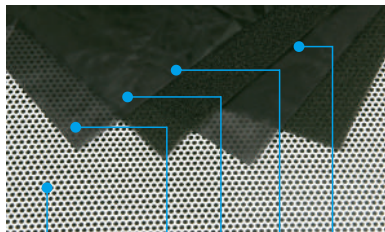
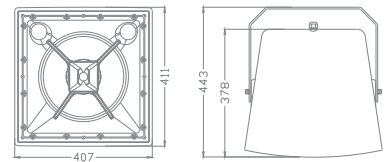
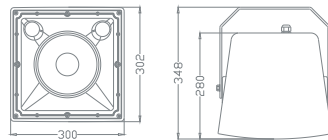
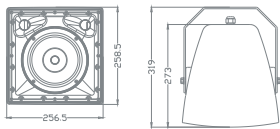

铝质喷涂面网+滤棉+网布+滤棉+网布
五层保护、防尘、防水面网
Aluminum grille with powder spray+foam+mesh
cloth+foam+mesh cloth, five-layer protection,
dustproof, waterproof grille

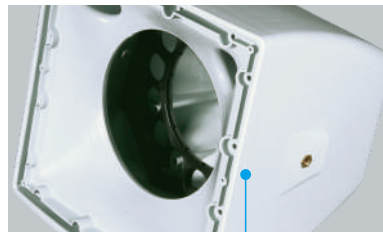

抗紫外线箱体材料
UV resistant housing material

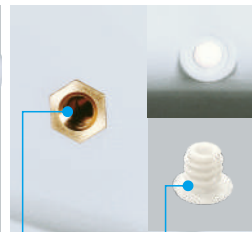

黄铜预埋螺母、防水硅胶盖
Brass embedded nut, waterproof
silicone cover

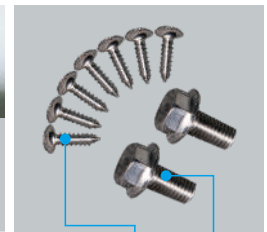

不锈钢螺丝(锁面网、支架安装)
Stainless steel screw to fix grille and
wall bracket



LT SERIES ALL-WEATHER MID-LONG THROW SPEAKER

LT215/LT215T

1x15" 2-way Coaxial
All-weather Speaker

DRIVERS	1 × 15" (385mm)/3" voice coil LF 1 × 1.4" (36mm)/3" voice coil HF
POWER	400W RMS, 1600W peak 75W/150W/300W/OFF/8Ω 400W

LT215L/LT215LT

1x15" 2-way Coaxial Coaxial
All-weather Line Array Speaker

DRIVERS	1 × 15" (385mm)/3" voice coil LF 1 × 1.4" (36mm)/3" voice coil HF
POWER	400W RMS, 1600W peak 75W/150W/300W/OFF/8Ω 400W

LT115B/LT115BT

1x15" All-weather Subwoofer

DRIVERS	1 × 15" (385mm)/3" voice coil LF
POWER	400W RMS, 1600W peak 75W/150W/300W/OFF/8Ω 400W

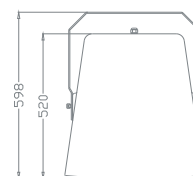
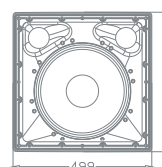
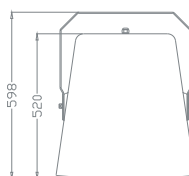
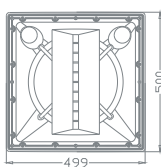
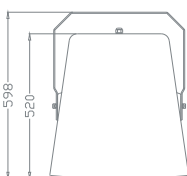
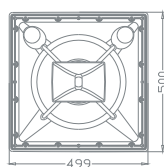

四位接线端
4 pins covered barrier strip
terminals

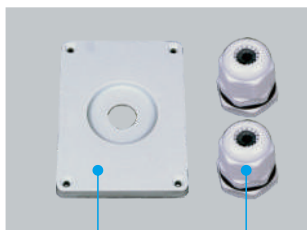

防尘防水盖、防尘防水迫紧头
Dustproof, waterproof back panel cover and connector

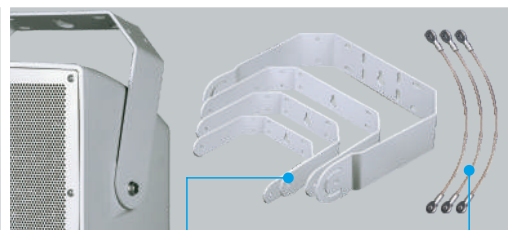

喷涂安装支架 (碳钢、不锈钢) 不锈钢保险绳
Wall bracket with powder spray (carbon steel, stainless steel),
stainless steel safty rope



FDB AUDIO MANUFACTURE CO.,LTD.

ACCESSORIES 附件

WALL BRACKET



LT206/LT206T

WALL BRACKET



LT208/LT208T

WALL BRACKET



LT212/LT212T

WALL BRACKET

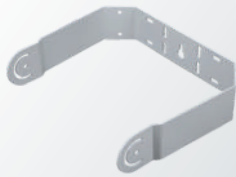

LT215/LT215T/LT215L/LT215LT
LT115B/LT115BT

SAFTY ROPE



BACK PANEL COVER



WATERPROOF CONNECTOR



WATERPROOF PVC GASKET



SILICONE COVER



NUTS AND SCREWS



SPEAKER CABLE





LT SERIES ALL-WEATHER MID-LONG THROW SPEAKER

SPECIFICATIONS

MODEL	LT206	LT206T	LT208	LT208T
FREQUENCY RESPONSE(-3dB)	--	--	80Hz-18kHz	80Hz-18kHz
FREQUENCY RESPONSE(-10dB)	100Hz-18kHz	100Hz-18kHz	75Hz-20kHz	75Hz-20kHz
DRIVERS	1×6.5"(165mm)/1.4" voice coil LF 1×0.8" (20mm)/1" voice coil HF	1×6.5"(165mm)/1.4" voice coil LF 1×0.8"(20mm)/1"voice coil HF	1×8" (200mm)/2" voice coil LF 1×1" (25mm)/1.4" voice coil HF	1×8" (200mm)/2" voice coil LF 1×1" (25mm)/1.4" voice coil HF
INPUT VOLTAGE	--	100V	--	100V
RATED POWER	100W RMS,400W peak	25W/50W/100W/OFF/8Ω	150W RMS,600W peak	37.5W/75W/150W/OFF/8Ω
SENSITIVITY	93dB 1watt/1 metre	93dB 1watt/1 metre	96dB 1watt/1 metre	96dB 1watt/1 metre
MAXIMUM SPL	113dB continuous,119dB peak	113dB continuous,119dB peak	118dB continuous,124dB peak	118dB continuous,124dB peak
IMPEDANCE	8 ohms nominal	8 ohms nominal	8 ohms nominal	8 ohms nominal
DISPERSION(-6dB)	100°×100°	100°×100°	80°×80°	80°×80°
CROSSOVER FREQUENCIES	2.8kHz passive	2.8kHz passive	2.5kHz passive	2.5kHz passive
INPUT CONNECTORS	covered barrier strip terminals	covered barrier strip terminals	covered barrier strip terminals	covered barrier strip terminals
PACKAGE SIZE	313mm×313mm×278mm	313mm×313mm×278mm	362mm×332mm×335mm	362mm×332mm×335mm
NET WEIGHT	6 kg/pc	7 kg/pc	10 kg/pc	11 kg/pc
GROSS WEIGHT	7.5 kg/pc	8.5 kg/pc	12 kg/pc	13 kg/pc

MODEL	LT212	LT212T	LT215	LT215T
FREQUENCY RESPONSE(-3dB)	55Hz-18kHz	55Hz-18kHz	50Hz-18kHz	50Hz-18kHz
FREQUENCY RESPONSE(-10dB)	50Hz-20kHz	50Hz-20kHz	45Hz-20kHz	45Hz-20kHz
DRIVERS	1×12"(300mm)/3"voice coil LF 1×1"(25mm)/1.7"voice coil HF	1×12"(300mm)/3"voice coil LF 1×1"(25mm)/1.7"voice coil HF	1×15"(385mm)/3"voice coil LF 1×1.4"(36mm)/3"voice coil HF	1×15"(385mm)/3"voice coil LF 1×1.4"(36mm)/3"voice coil HF
INPUT VOLTAGE	--	100V	--	100V
RATED POWER	300W RMS,1200W peak	50W/100W/200W/OFF/8Ω 300W	400W RMS,1600W peak	75W/150W/300W/OFF/8Ω 400W
SENSITIVITY	98dB 1watt/1 metre	98dB 1watt/1 metre	103dB 1watt/1 metre	103dB 1watt/1 metre
MAXIMUM SPL	123dB continuous,129dB peak	123dB continuous,129dB peak	129dB continuous,135dB peak	129dB continuous,135dB peak
IMPEDANCE	8 ohms nominal	8 ohms nominal	8 ohms nominal	8 ohms nominal
DISPERSION(-6dB)	70°×50°	70°×50°	60°×40°	60°×40°
CROSSOVER FREQUENCIES	2.2kHz passive	2.2kHz passive	1.5kHz passive	1.5kHz passive
INPUT CONNECTORS	covered barrier strip terminals	covered barrier strip terminals	covered barrier strip terminals	covered barrier strip terminals
PACKAGE SIZE	472mm×442mm×460mm	472mm×442mm×460mm	610mm×585mm×570mm	610mm×585mm×570mm
NET WEIGHT	18 kg/pc	20 kg/pc	28.5 kg/pc	31 kg/pc
GROSS WEIGHT	20 kg/pc	22 kg/pc	31.5 kg/pc	34 kg/pc

MODEL	LT215L	LT215LT	LT115B	LT115BT
FREQUENCY RESPONSE(-3dB)	50Hz-18kHz	50Hz-18kHz	45Hz-300Hz	45Hz-300Hz
FREQUENCY RESPONSE(-10dB)	45Hz-20kHz	45Hz-20kHz	--	--
DRIVERS	1×15"(385mm)/3"voice coil LF 1×1.4"(36mm)/3"voice coil HF	1×15"(385mm)/3"voice coil LF 1×1.4"(36mm)/3"voice coil HF	1×15"(385mm)/3"voice coil LF --	1×15"(385mm)/3"voice coil LF --
INPUT VOLTAGE	--	100V	--	100V
RATED POWER	400W RMS,1600W peak	75W/150W/300W/OFF/8Ω400W	400W RMS,1600W peak	75W/150W/300W/OFF/8Ω400W
SENSITIVITY	103dB 1watt/1 metre	103dB 1watt/1 metre	98dB 1watt/1 metre	98dB 1watt/1 metre
MAXIMUM SPL	129dB continuous,135dB peak	129dB continuous,135dB peak	124dB continuous,130dB peak	124dB continuous,130dB peak
IMPEDANCE	8 ohms nominal	8 ohms nominal	8 ohms nominal	8 ohms nominal
DISPERSION(-6dB)	60°×25°	60°×25°	--	--
CROSSOVER FREQUENCIES	1.5kHz passive	1.5kHz passive	--	--
INPUT CONNECTORS	covered barrier strip terminals	covered barrier strip terminals	covered barrier strip terminals	covered barrier strip terminals
PACKAGE SIZE	610mm×585mm×570mm	610mm×585mm×570mm	610mm×585mm×570mm	610mm×585mm×570mm
NET WEIGHT	29 kg/pc	31.5 kg/pc	22 kg/pc	24.5 kg/pc
GROSS WEIGHT	32 kg/pc	34.5 kg/pc	25 kg/pc	27.5 kg/pc



FDB AUDIO MANUFACTURE CO.,LTD.

ES SERIES

ALL-WEATHER MULTI-PURPOSE ENGINEERING SPEAKER

ES series is a group of two-way all-weather speakers with different colors and functions. With waterproof, dustproof, windproof, anti-uv aging, specially designed dustproof and waterproof cover for input and output, has a pressing device, multi-layer different functional grille. The cabinet meets the IP46 standard. The exposed metal parts are made of stainless steel or aluminum, and the mounting bracket is sprayed with low-carbon steel, which can meet all-weather use (the version suitable for the marine environment can be customized, and the mounting bracket is upgraded to 316 stainless steel). the cabinet is made of polymer compound injection molding. B and W after the model represent black and white, T represents the configuration of transformer and band switch, to achieve a variety of different output powers including constant resistance.

ES系列型号是一组两分音不同颜色及功能的全天候系列音箱。具有防水、防尘、防风、抗紫外线老化、输入输出用专门设计的防尘防水盖板，并有迫紧装置，多层不同功能面网。产品满足IP46标准，外露金属件采用不锈钢或铝质喷涂，安装支架为低碳钢喷涂，满足全天候使用(可以定制适应海洋环境的版本，安装支架升级为316不锈钢)，箱体采用高分子化合物射出成型。型号后的B、W分别代表黑色和白色，T表示配置音频变压器及波段开关，实现多种不同输出功率包括定阻。

ES104W/ES104WT



ES106W/ES106WT



ES108W/ES108WT



ES104B/ES104BT

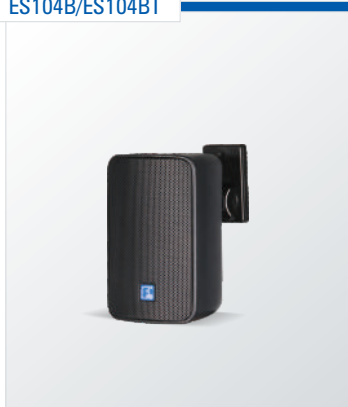

ES106B/ES106BT



ES108B/ES108BT





ES SERIES ALL-WEATHER MULTI-PURPOSE ENGINEERING SPEAKER



FEATURES

- Pass IP46 testing, meet all-weather use
- The cabinet is made of polymer compound injection molding
- Customized unit, better bass performance
- Applications: outdoor restaurants, bars, conference rooms, classrooms, parks, sound reinforcement of scenic areas, houseboat and seascides(customized)

产品特征

- 产品通过IP46测试，满足全天候使用
- 箱体采用高分子化合物射出成型。
- 特制单元，有较好的低音表现
- 适用范围：户外餐厅、酒吧、教室、会议室、主题公园、景区扩声、游艇、海边户外近场扩声(需定制)

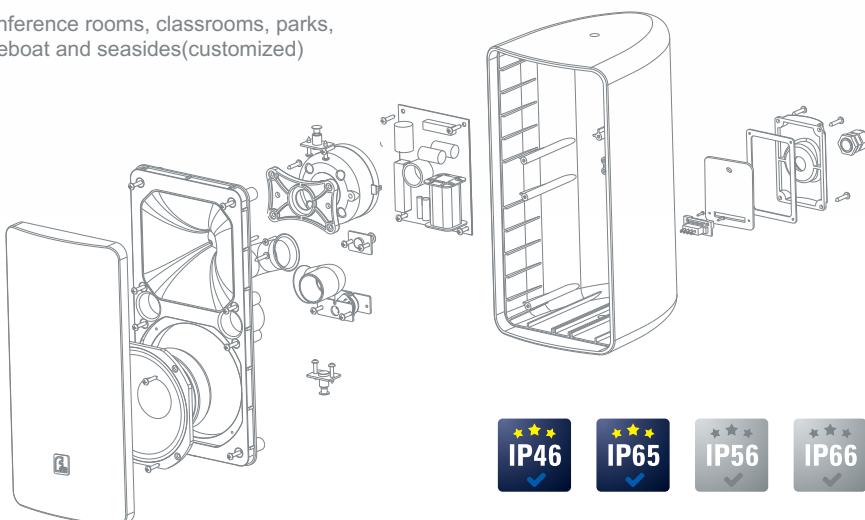



FDB AUDIO MANUFACTURE CO.,LTD.

ES104/ES104T

1x4" 2-way All-weather
Small Plastic Multi-purpose Speaker

DRIVERS	1 × 4" (100mm) / 1" voice coil LF 1 × 0.8" (20mm) / dome tweeter
RATED POWER	40W RMS, 160W peak 10W/20W/40W/OFF/16Ω

ES106/ES106T

1x6" 2-way All-weather
Small Plastic Multi-purpose Speaker

DRIVERS	1 × 6" (150mm) / 1.5" voice coil LF 1 × 1" (25mm) / 1" voice coil HF
RATED POWER	80W RMS, 320W peak 20W/40W/80W/OFF/16Ω

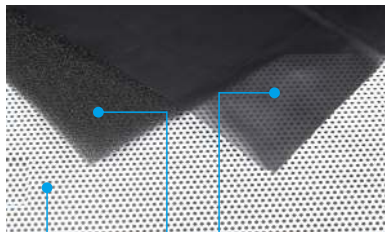
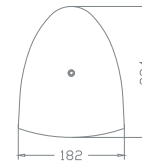
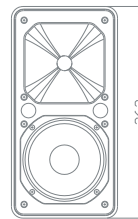
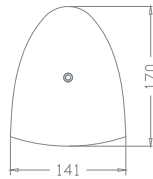
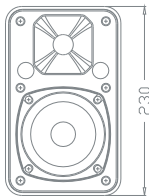

铝质喷涂面网+滤棉+网布
三层保护、防尘、防水面网
Aluminum grille with powder spray+foam+mesh
cloth, three-layer protection, dustproof,
waterproof grille



抗紫外线箱体材料
UV resistant housing material

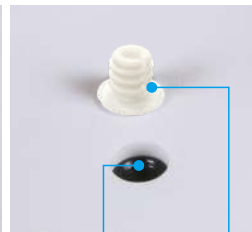

黄铜预埋螺母、防水硅胶盖
Brass embedded nut, waterproof
silicone cover

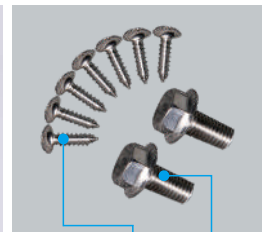

不锈钢螺丝(锁面网、支架安装)
Stainless steel screw to fix grille and
wall bracket



ES SERIES ALL-WEATHER MULTI-PURPOSE ENGINEERING SPEAKER

ES108/ES108T

1x8" 2-way All-weather
Small Plastic Multi-purpose Speaker

DRIVERS	1 × 8" (200mm) / 2" voice coil LF
	1 × 1" (25mm) / 1" voice coil HF
RATED POWER	150W RMS, 600W peak
	37.5W/70W/150W/OFF/16Ω

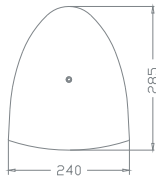
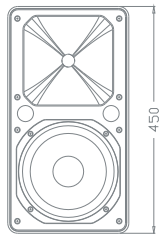

凤凰插座与插头
Phoenix connector



防尘防水盖、防尘防水迫紧头
Dustproof, waterproof back panel cover and connector



喷涂安装支架 (碳钢、不锈钢) 不锈钢保险绳
Wall bracket with powder spray (carbon steel, stainless steel), stainless steel safty rope



ACCESSORIES

附件

WALL BRACKET



ES104B/ES104W/ES104BT/ES104WT

WALL BRACKET



ES106B/ES106W/ES106BT/ES106WT

WALL BRACKET



ES108B/ES108W/ES108BT/ES108WT

BACK PANEL COVER



ES104

ES106

ES108

WATERPROOF CONNECTOR



SAFTY ROPE



WATERPROOF PVC GASKET



SILICONE COVER



PHOENIX CONNECTOR



NUTS AND SCREWS



SPEAKER CABLE





ES SERIES ALL-WEATHER MULTI-PURPOSE ENGINEERING SPEAKER

SPECIFICATIONS

MODEL	ES104B/ES104W	ES104BT/ES104WT
FREQUENCY RESPONSE(-3dB)	75Hz-20kHz	75Hz-20kHz
FREQUENCY RESPONSE(-10dB)	70Hz-20kHz	70Hz-20kHz
DRIVERS	1 × 4"(100mm)/1"voice coil LF 1 × 0.8"(20mm)/dome tweeter	1 × 4"(100mm)/1"voice coil LF 1 × 0.8"(20mm)/dome tweeter
INPUT VOLTAGE	--	100V
RATED POWER	40W RMS,160W peak	10W/20W/40W/OFF/16Ω
SENSITIVITY	88dB 1watt/1 metre	88dB 1watt/1 metre
MAXIMUM SPL	104dB continuous,110dB peak	104dB continuous,110dB peak
IMPEDANCE	16 ohms nominal	16 ohms nominal
DISPERSION(-6dB)	120° × 90°	120° × 90°
CROSSOVER FREQUENCIES	3.5kHz passive	3.5kHz passive
INPUT CONNECTORS	covered barrier strip terminals	covered barrier strip terminals
PACKAGE SIZE	412mm × 192mm × 271mm(1Pair)	412mm × 192mm × 271mm(1Pair)
NET WEIGHT	2 kg/pc	3 kg/pc
GROSS WEIGHT	6 kg/pair	7 kg/pair

MODEL	ES106B/ES106W	ES106BT/ES106WT
FREQUENCY RESPONSE(-3dB)	60Hz-18kHz	60Hz-18kHz
FREQUENCY RESPONSE(-10dB)	55Hz-20kHz	55Hz-20kHz
DRIVERS	1 × 6"(150mm)/1.5"voice coil LF 1 × 1"(25mm)/1"voice coil HF	1 × 6"(150mm)/1.5"voice coil LF 1 × 1"(25mm)/1"voice coil HF
INPUT VOLTAGE	--	100V
RATED POWER	80W RMS,320W peak	20W/40W/80W/OFF/16Ω
SENSITIVITY	89dB 1watt/1 metre	89dB 1watt/1 metre
MAXIMUM SPL	108dB continuous,114dB peak	108dB continuous,114dB peak
IMPEDANCE	16 ohms nominal	16 ohms nominal
DISPERSION(-6dB)	90° × 60°	90° × 60°
CROSSOVER FREQUENCIES	2.4kHz passive	2.4kHz passive
INPUT CONNECTORS	covered barrier strip terminals	covered barrier strip terminals
PACKAGE SIZE	528mm × 222mm × 415mm(1 pair)	528mm × 222mm × 415mm(1 pair)
NET WEIGHT	5 kg/pc	6 kg/pc
GROSS WEIGHT	15 kg/pair	16 kg/pair

MODEL	ES108B/ES108W	ES108BT/ES108WT
FREQUENCY RESPONSE(-3dB)	60Hz-18kHz	60Hz-18kHz
FREQUENCY RESPONSE(-10dB)	55Hz-20kHz	55Hz-20kHz
DRIVERS	1 × 8"(200mm)/2"voice coil LF 1 × 1"(25mm)/1"voice coil HF	1 × 8"(200mm)/2"voice coil LF 1 × 1"(25mm)/1"voice coil HF
INPUT VOLTAGE	--	100V
RATED POWER	150W RMS,600W peak	37.5W/75W/150W/OFF/16Ω
SENSITIVITY	94dB 1watt/1 metre	94dB 1watt/1 metre
MAXIMUM SPL	116dB continuous,122dB peak	116dB continuous,122dB peak
IMPEDANCE	16 ohms nominal	16 ohms nominal
DISPERSION(-6dB)	90° × 50°	90° × 50°
CROSSOVER FREQUENCIES	2.3kHz passive	2.3kHz passive
INPUT CONNECTORS	covered barrier strip terminals	covered barrier strip terminals
PACKAGE SIZE	352mm × 292mm × 505mm	352mm × 292mm × 505mm
NET WEIGHT	9 kg/pc	10 kg/pc
GROSS WEIGHT	11 kg/pc	12 kg/pc



FDB AUDIO MANUFACTURE CO.,LTD.

CL SERIES

ALL-WEATHER MULTI-FUNCTION COLUMN SPEAKER

CL series are all-weather column speakers with different colours or functions, with waterproof, dustproof, windproof, anti-uv aging, dustproof and waterproof covers specially designed for input and output, and multi-layer different functional grille. The product meets the IP56 standard. The exposed metal parts are sprayed with stainless steel or aluminum, and the mounting bracket is sprayed with low-carbon steel to meet all-weather use. The sound is soft and balanced. Unit configuration: 4" 25mm voice coil ferrite mid-bass units, 1" exit throat 34mm HF driver with horn, the cabinet is made of aluminum alloy, and the upper and lower panels of the cabinet are die-cast. The B and W after the model represent black, T represents the configuration of transformer and band switch to achieve a variety of different output powers including constant resistance.

CL系列型号是一组两分音不同颜色或功能的全天候音柱，具有防水、防尘、防风、抗紫外线老化、输入输出专门设计的防尘防水盖，多层不同功能面网。产品满足IP56标准，外露金属件采用不锈钢或铝质喷涂，安装支架为低碳钢喷涂，满足全天候使用，声音柔和平衡。单元配置：4"25芯铁氧体中低音单元，1"喉口34芯高音驱动器+号角，箱体采用铝合金挤出成型，箱体上下板采用压铸成型。型号后的B、W分别代表黑色和白色，T表示配置音频变压器及波段开关，实现多种不同输出功率包括定阻。

CL4023W/CL4023WT



CL4025W/CL4025WT



CL4027W/CL4027WT



CL4023B/CL4023BT



CL4025B/CL4025BT



CL4027B/CL4027BT





CL SERIES ALL-WEATHER MULTI-FUNCTION COLUMN SPEAKER



FEATURES

- Product parameters have been entered into EASE loudspeaker database
- Pass IP56 testing
- Aluminum alloy housing, impact resistance, weather resistance
- Two-way design, wide horizontal and vertical angles, soft and balanced sound
- Various installation methods, easy and fast operation
- Applications: outdoor sound reinforcement, parks, churches, conference rooms, classrooms, sound reinforcement for outdoor screens

产品特点

- 产品参数已录入EASE扬声器数据库
- 通过IP56测试
- 铝合金箱体，耐冲击、抗风雨
- 两分音，水平及垂直角度较宽、声音柔和平衡
- 多种安装方式，操作简易快捷
- 适用范围：户外扩声、主题公园、教堂、会议室、教室、户外大屏扩声

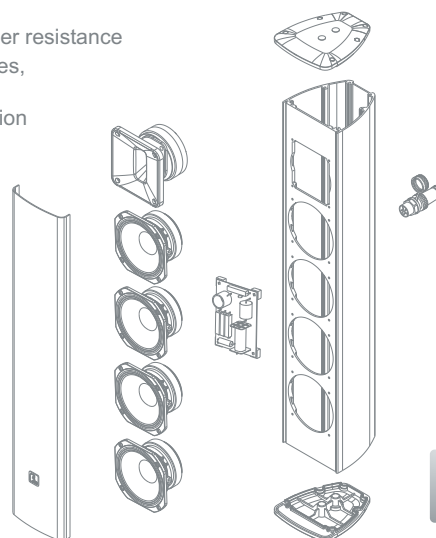



FDB AUDIO MANUFACTURE CO.,LTD.

CL4023/CL4023T

2x4" 2-way All-weather
Multi-function Column Speaker

DRIVERS	2 × 4" (100mm) / 1" voice coil LF 1 × 1" (25mm) / 1.4" voice coil HF
RATED POWER	65W RMS, 260W peak 15W/30W/60W/OFF/8Ω 65W

CL4025/CL4025T

4x4" 2-way All-weather
Multi-function Column Speaker

DRIVERS	4 × 4" (100mm) / 1" voice coil LF 1 × 1" (25mm) / 1" voice coil HF
RATED POWER	130W RMS, 520W peak 30W/60W/120W/OFF/8Ω 130W



CL4023B/CL4023W

CL4023BT/CL4023WT

CL4025B/CL4025W

CL4025BT/CL4025WT

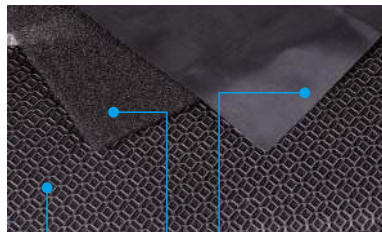
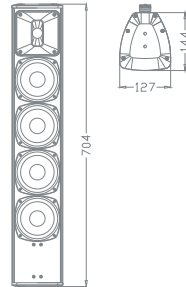
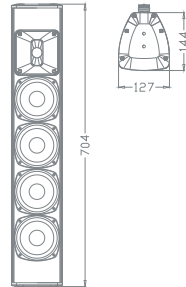
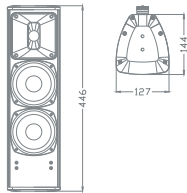
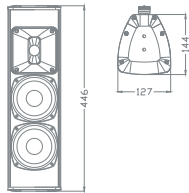

铝质喷涂面网+滤棉+网布
三层保护、防尘、防水面网
Aluminum grille with powder spray+foam+mesh
three-layer protection, dustproof, waterproof grille



铝合金喷涂箱体
喷涂上下盖
Aluminum housing with powder spray
Top and bottom cover with powder spray



Kevlar
防水鼓纸单元
Kevlar waterproof paper cone unit



防尘防水插座、插头
Dustproof, waterproof M22-2P connector



防水硅胶盖
不锈钢上下盖锁紧螺丝
Waterproof silicone cover, stainless steel screws to fix top and bottom cover



CL SERIES ALL-WEATHER MULTI-FUNCTION COLUMN SPEAKER

CL4027/CL4027T

6x4" 2-way All-weather
Multi-function Column Speaker

DRIVERS	6 × 4" (100mm) / 1" voice coil LF
	1 × 1" (25mm) / 1" voice coil HF
RATED POWER	200W RMS, 800W peak
	37.5W/75W/150W/OFF/8Ω 200W



CL4027B/CL4027W

CL4027BT/CL4027WT

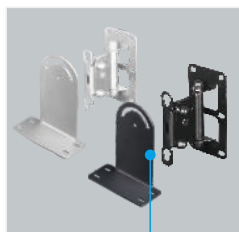

喷涂安装支架(碳钢、不锈钢)
Wall bracket with powder spray
(carbon steel, stainless steel)

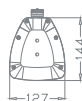
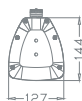



ACCESSORIES
附件

WALL BRACKET 9



WALL BRACKET 9



WALL BRACKET 4



WATERPROOF PVC GASKET



SILICONE COVER



NUTS AND SCREWS



WATERPROOF M22-2P CONNECTOR



SPEAKER CABLE





CL SERIES ALL-WEATHER MULTI-FUNCTION COLUMN SPEAKER

SPECIFICATIONS

MODEL	CL4023B/CL4023W	CL4023BT/CL4023WT
FREQUENCY RESPONSE(-10dB)	120Hz-18kHz	120Hz-18kHz
DRIVERS	2 × 4"(100mm)/1"voice coil LF 1 × 1"(25mm)/1.4"voice coil HF	2 × 4"(100mm)/1"voice coil LF 1 × 1"(25mm)/1.4"voice coil HF
INPUT VOLTAGE		100V
RATED POWER	65W RMS,260W peak	15W/30W/60W/OFF/8Ω65W
SENSITIVITY	91dB 1watt/1 metre	91dB 1watt/1 metre
MAXIMUM SPL	109dB continuous,115dB peak	109dB continuous,115dB peak
IMPEDANCE	8 ohms nominal	8 ohms nominal
DISPERSION(-6dB)	100° × 60°	100° × 60°
CROSSOVER FREQUENCIES	1.8kHz passive	1.8kHz passive
INPUT CONNECTORS	M22-2P	M22-2P
PACKAGE SIZE	517mm × 380mm × 193mm(1Pair)	517mm × 380mm × 193mm(1Pair)
NET WEIGHT	5.5 kg/pc	6 kg/pc
GROSS WEIGHT	13 kg/pair	14 kg/pair

MODEL	CL4025B/CL4025W	CL4025BT/CL4025WT
FREQUENCY RESPONSE(-10dB)	120Hz-18kHz	120Hz-18kHz
DRIVERS	4 × 4"(100mm)/1"voice coil LF 1 × 1"(25mm)/1.4"voice coil HF	4 × 4"(100mm)/1"voice coil LF 1 × 1"(25mm)/1.4"voice coil HF
INPUT VOLTAGE		100V
RATED POWER	130W RMS,520W peak	30W/60W/120W/OFF/8Ω130W
SENSITIVITY	94dB 1watt/1 metre	94dB 1watt/1 metre
MAXIMUM SPL	115dB continuous,121dB peak	115dB continuous,121dB peak
IMPEDANCE	8 ohms nominal	8 ohms nominal
DISPERSION(-6dB)	100° × 50°	100° × 50°
CROSSOVER FREQUENCIES	1.9kHz passive	1.9kHz passive
INPUT CONNECTORS	M22-2P	M22-2P
PACKAGE SIZE	775mm × 380mm × 193mm(1 pair)	775mm × 380mm × 193mm(1 pair)
NET WEIGHT	8.5 kg/pc	9 kg/pc
GROSS WEIGHT	20 kg/pair	21 kg/pair

MODEL	CL4027B/CL4027W	CL4027BT/CL4027WT
FREQUENCY RESPONSE(-10dB)	120Hz-18kHz	120Hz-18kHz
DRIVERS	6 × 4"(100mm)/1"voice coil LF 1 × 1"(25mm)/1.4"voice coil HF	6 × 4"(100mm)/1"voice coil LF 1 × 1"(25mm)/1.4"voice coil HF
INPUT VOLTAGE		100V
RATED POWER	200W RMS,800W peak	37.5W/75W/150W/OFF/6Ω200W
SENSITIVITY	96dB 1watt/1 metre	96dB 1watt/1 metre
MAXIMUM SPL	119dB continuous,125dB peak	119dB continuous,125dB peak
IMPEDANCE	6 ohms nominal	6 ohms nominal
DISPERSION(-6dB)	100° × 40°	100° × 40°
CROSSOVER FREQUENCIES	2.2kHz passive	2.2kHz passive
INPUT CONNECTORS	M22-2P	M22-2P
PACKAGE SIZE	1050mm × 380mm × 193mm(1 pair)	1050mm × 380mm × 193mm(1 pair)
NET WEIGHT	11 kg/pc	12 kg/pc
GROSS WEIGHT	26 kg/pair	27 kg/pair



FDB AUDIO MANUFACTURE CO.,LTD.

LS SERIES

ALL-WEATHER LANDSCAPE SPEAKER

LS series is specially designed for outdoor applications, strong weather resistance speaker, with ingenious, stylish, compact structure design, close to the ground or buried installation, full bass, bright mid-high, grass green can be integrated with the environment. The product has passed the IP56 test, and the coverage angle is 360°×90°. Unit configuration: 5" and 8" coaxial units, the cabinet is molded with grass-green engineering plastic material, which is resistant to collisions and scratches.

LS系列是专为户外应用，耐候性极强的音箱，巧妙、时尚、紧凑型结构设计，贴地或埋地安装，低音丰满、中高音明亮，草绿色可与环境融为一体。产品通过IP56测试，360°×90°覆盖角度。单元配置：5"、8"同轴单元，箱体采用草绿色工程塑胶材料模具成型，耐碰撞和刮花。



SPECIFICATIONS

MODEL	LS525	LS800
FREQUENCY RESPONSE(-3dB)	65Hz-16KHz	60Hz-16KHz
FREQUENCY RESPONSE(-10dB)	55Hz-18kHz	50Hz-18kHz
DRIVERS	1×5.25"(135mm)/1.5"voice coil LF 1×0.8"(20mm)/dome tweeter	1×8"(200mm)/1.5"voice coil LF 1×1"(25mm)/dome tweeter
INPUT VOLTAGE	100V	100V
RATED POWER	7.5W/15W/30W/OFF/8Ω	15W/30W/60W/OFF/8Ω
SENSITIVITY	86dB 1watt/1 metre	93dB 1watt/1 metre
MAXIMUM SPL	100dB continuous,106 dB peak	110dB continuous,116 dB peak
IMPEDANCE	8 ohms nominal	8 ohms nominal
DISPERSION(-6dB)	360°×90°	360°×90°
CROSSOVER FREQUENCIES	3.2kHz passive	2.8kHz passive
PACKAGE SIZE	405mm×405mm×500mm	470mm×470mm×585mm
NET WEIGHT	6.5kg/pc	9.5kg/pc
GROSS WEIGHT	8.5kg/pc	12kg/pc



LS SERIES ALL-WEATHER LANDSCAPE SPEAKER

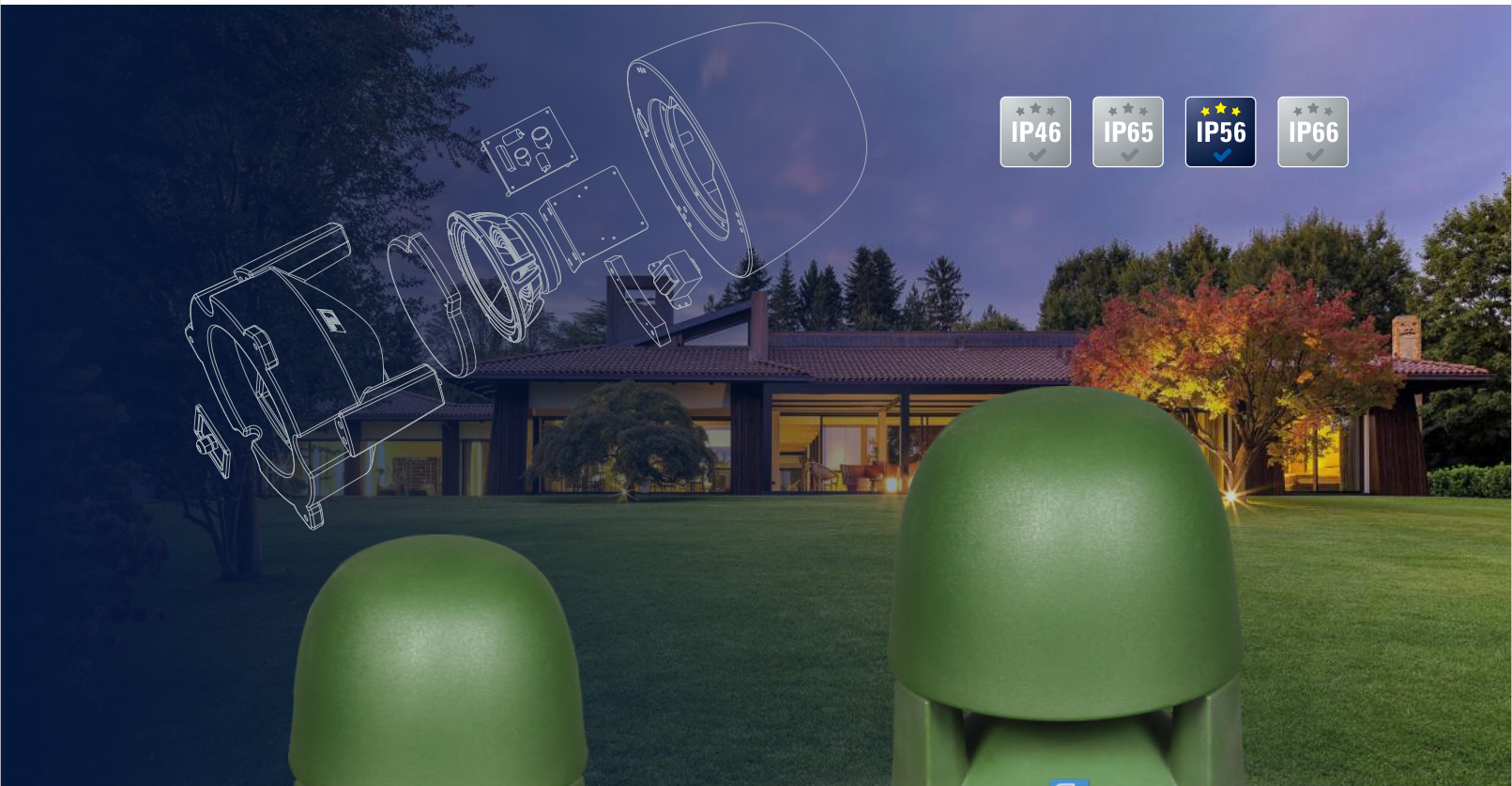

FEATURES

- Pass IP56 testing
- Engineering plastic mold forming box, strong weather resistance
- 360°×90° coverage angle
- Applications: green square, pedestrian walkway, park, hotel garden, resorts, villa courtyards

产品特征

- 通过IP56测试
- 工程塑胶模具成型箱体, 耐候性极强
- 360°×90°覆盖角度
- 适用范围: 绿地广场、人行栈道、公园、酒店花园、度假村、别墅院落

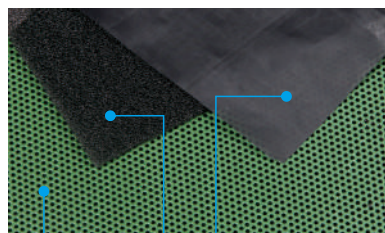

铝质喷涂面网+滤棉+网布
三层保护、防尘、防水面网

Aluminum grille with powder spray+foam+mesh cloth, three-layer protection, dustproof, waterproof grille



抗紫外线箱体材料
黄铜预埋螺母

UV resistant housing material
Brass embedded nut



铝质面网
不锈钢螺丝

Aluminum grille,
stainless steel screw to fix grille



车载级防水单元

Vehicle-mounted waterproof unit



我们的承诺 OUR PROMISE

尊敬的客户，感谢您选用fdB产品，fdB的产品研发、材料采购、产品制造、质量验证、客户服务、持续改善过程满足ISO9001:2015质量管理体系标准的要求，请放心选用，为此fdB承诺：

一. fdB电声产品，自购买之日起享有5年免费质保。5年质保期内，fdB免费维修正常使用情况下出现的故障或免费提供零、配件。

二. fdB电子产品，自购买之日起享有3年免费质保。3年质保期内，fdB免费维修正常使用情况下出现的故障或免费提供元器件或配件。

三. 因非正常使用，例如：系统搭配不合理而造成低音喇叭烧音圈，电子产品使用电压与产品标注电压不符而造成的损坏，fdB只按成本价收取维修费用、收取元器件或配件费用。

此承诺书的最终解释权归属fdB。

Dear customer, thank you for choosing fdB products, all the research and development, material procurement, product manufacturing, quality control, customer service and continuous improvement process of fdB products all meet the requirements of ISO9001:2015 quality management system standard, please feel free to choose, and fdB promises:

1. fdB electroacoustic products, enjoy 5 years free warranty from the date of purchase. During the warranty period, fdB will free repair the products damaged under normal use or provide the free spare parts damaged under normal.

2. fdB electronic products enjoy 3 years warranty from the date of purchase. During the warranty period, fdB will free repair the products damaged under normal use or provide the free components or accessories damaged under normal use.

3. Due to abnormal use, such as woofer voice coil burnt caused by unreasonable system collocation, electronic products damaged caused by inconsistent voltage, charging maintenance fees or charging components and accessories fees at cost price.

fdB has the right of final interpretation of this commitment.



FDB AUDIO MANUFACTURE CO.,LTD.
Tel: +86 (0)769-22781017 +86 (0)769-22781297
www.fdbaudio.com www.fdb-proaudio.com
marketing@fdbaudio.com



官方网站



微信公众号